



Ditec DAS107PLUS

Automation for sliding doors

(Translation of the original instructions)

IP2282EN • 2019-07-16
Technical Manual

Contents

	Subject	Page
1.	General safety precautions	3
	Declaration of incorporation of partly completed machinery	4
2.	Technical specifications	5
2.1	Operating instructions	5
3.	Standard installation	6
4.	Main components	7
5.	Installing the automation	7
5.1	Removing the cover	7
5.2	Fastening of box using supplied wing anchoring brackets	8
5.3	Example with DAS11M8 and DAS18M8	9
5.4	Preparing the glass door wing	10
5.5	Installing and adjusting the door wings	11
5.6	Installing the floor guides	13
5.7	Adjusting the belt	13
5.8	Installing the door wing block (optional)	14
6.	Electrical connections	14
6.1	Standard electrical connections	15
6.2	Control panel commands	16
6.2.1	Commands	16
7.	Adjustment and selection of control functions	18
7.1	Status indication on the display	19
8.	Start up	20
9.	Parameters	22
9.1	Configuration parameters according to function	22
9.2	Description of the parameters	23
10.	Example of connection	26
10.1	Example of connection with opening radar and photocell	26
10.2	Combined opening and safety sensor + safety sensor on opening	27
11.	Troubleshooting / alarms	28
11.1	Alarms	28
12.	Routine maintenance plan	31

Key



This symbol indicates instructions or notes regarding safety, to which special attention must be paid.



This symbol indicates useful information for the correct functioning of the product.

1. General safety precautions



Failure to respect the information given in this manual may cause personal injury or damage to the device.
Keep these instructions for future reference

This assembly and installation manual is intended exclusively for the use of qualified personnel. Installation, electrical connections and adjustments must be performed by qualified personnel, in accordance with Good Working Methods and in compliance with the current regulations.

Read the instructions carefully before installing the product.

Incorrect installation could be dangerous.



The packaging materials (plastic, polystyrene, etc.) should not be discarded in the environment or left within reach of children, as they are a potential source of danger.

Before installing the product, make sure it is in perfect condition.

Do not install the product in explosive areas and atmospheres: the presence of inflammable gas or fumes represents a serious safety hazard.

Before installing the motorisation device, make all the necessary structural modifications to create safety clearance and to guard or isolate all the crushing, shearing, trapping and general hazardous areas.

Make sure the existing structure is up to standard in terms of strength and stability. The motorisation device manufacturer is not responsible for failure to observe Good Working Methods when building the frames to be motorised, or for any deformations during use.

The safety devices (photocells, safety edges, emergency stops, etc.) must be installed taking into account the applicable laws and directives, Good Working Methods, installation premises, system operating logic and the forces developed by the motorised door or gate.

The safety devices must protect against crushing, cutting, trapping and general danger areas of the motorised door or gate.

Display the signs required by law to identify hazardous areas.

Each installation must bear a visible indication of the data identifying the motorised door or gate.



When necessary, connect the motorised door or gate to an effective earthing system that complies with the current safety standards.

During installation, maintenance and repair operations, cut off the power supply before opening the cover to access the electrical parts.

The automation protection casing must be removed by qualified personnel only.

The electronic parts must be handled using earthed antistatic conductive arms. The manufacturer of the motorisation device declines all responsibility if component parts not compatible with safe and correct operation are fitted.



Only use original spare parts when repairing or replacing products.

The installer must supply all information concerning the automatic, manual and emergency operation of the motorised door or gate, and must provide the user with the operating instructions.

Declaration of incorporation of partly completed machinery

We:

Entrematic Group AB
Lodjursgatan 10
SE-261 44 Landskrona
Sweden

declare under our responsibility that the following types of equipment:

Ditec DAS107PLUS

comply with the following directives:

2014/30/EU Electromagnetic Compatibility Directive (EMCD)
2006/42/EC Machinery Directive (MD) for the following essential health and safety requirements: 1.1.2, 1.2.1, 1.2.2, 1.2.3, 1.2.4.2, 1.2.6, 1.3.9, 1.4.3, 1.7.2, 1.7.4, 1.7.4.1, 1.7.4.2

Technical documentation for safe integration supplied.

Harmonised European standards which have been applied:

EN 60335 -1:2012+A13:2017	EN ISO 13849 -1:2015	EN 61000 -6-2:2005
EN 60335-2-103:2015	EN 16005:2012/AC:2015	EN 61000 -6-3:2007+A1:2011

Other standards or technical specifications, which have been applied:

IEC 60335-1: 2010 ed.5 IEC 60335-2-103:2006+A1:2010 DIN 18650-1:2010

CE type examination or certificate issued by a notified or competent body (for the full address, contact Entrematic Group AB) for the equipment:

B 085479 0008

The production process aims to guarantee that the equipment complies with the technical documentation.

The production process is regularly assessed by an independent body.

The equipment must not be put into service until the final door system installed has been declared compliant with the Machinery Directive 2006/42/EC by the installer.

Person in charge of technical data sheet:

Matteo Fino

E-mail: matteo.fino@entrematic.com

Entrematic Group AB
Lodjursgatan 10
SE-261 44 Landskrona
Sweden

Place
Landskrona

Date
2019-07-16

Signature
Matteo Fino

Position
Entrance Automation President

2. Technical specifications

Power supply	100V~ / 240V~ 50/60Hz
Rated power	75W
Opening speed (2 door wings)	1m/s
Closing speed (2 door wings)	1m/s
Maximum load	120kg (1 door wing) 160kg (2 door wing)
Service class	5 - HEAVY DUTY
Intermittence	S3=100%
Temperature	 -20°C  +50°C
Degree of protection	IP20 (FOR INTERNAL USE ONLY)
Power supply for accessories	24V  0,64A
Durability test	1.000.000 cycles

2.1 Operating instructions

Service class: 5 (minimum 5 years of working life with 600 cycles per day).

Applications: HEAVY DUTY (for entrances with very intense pedestrian use).

- The performance characteristics refer to the recommended weight (approx. 2/3 of the maximum weight allowed). When used with the maximum permissible weight a reduction in the above mentioned performance can be expected.
- The service class and number of consecutive cycles should be taken merely as a rough indication, having been statistically determined under average operating conditions, and are therefore not necessarily applicable to specific conditions of use.
- Each automatic entrance has variable elements such as: friction, balancing and environmental factors, all of which may substantially alter the performance characteristics of the automatic entrance or curtail its working life or parts thereof (including the automatic devices themselves). The installer should adopt suitable safety conditions for each particular installation.

3. Standard installation

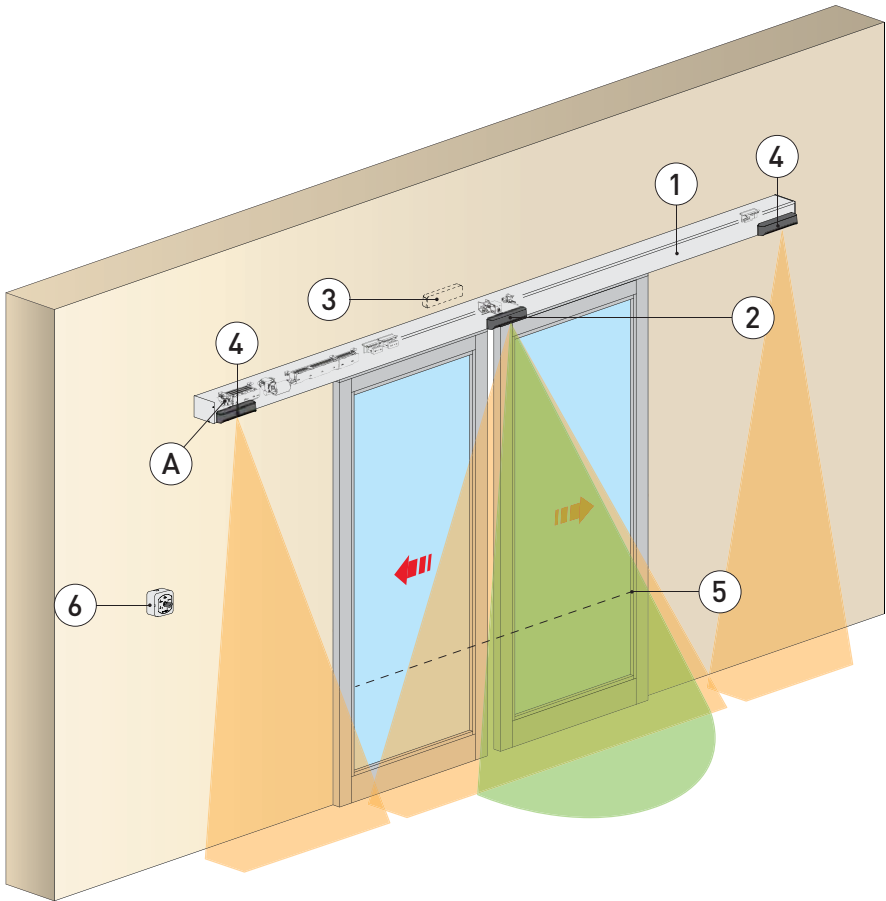

Ref.	Code	Description
1	DAS107PLUS	Automation for sliding doors
2	PAS024AS/W	Combined opening and safe closing sensor (microwave 24 GHz + active infrared)
3	or	
	PASAA2	Combined opening and safe closing sensor (active infrared)
4	PAS005AP	Safe opening sensor (active infrared)
5		Safety photocell
6	COM500MKS	Function selector switch
A	Connect the power supply cable to a type-approved omnipolar switch with category III insulation and a contact opening distance of at least 3 mm. The connections to the mains and low voltage wires must be made on an independent channel separated from the connections to the command and safety devices (SELV = Safety Extra Low Voltage).	

4. Main components

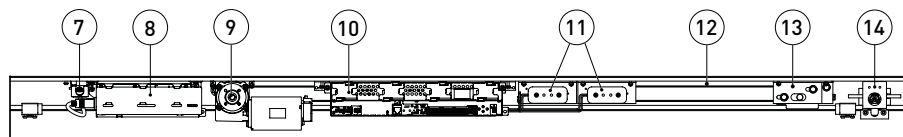

Ref.	Code	Description
7		Mains power supply
8	1DAS1ALP	75W power supply unit
9	1DAS1MR	Gearmotor
10	1DAS1QEP	Control panel
11	DAS901BAT1 DAS902BAT2	12V batteries (optional) 24V batteries (optional)
12		Drive belt
13		Belt transmission
14	DAS801LOK DAS801LOKA	Lock with external lock release lever Anti-panic lock



NB: the given operating and performance features can only be guaranteed with the use of DITEC Entrematic accessories and safety devices.

5. Installing the automation

5.1 Removing the cover

Loosen screw C to free the cover supports and lift the cover to remove it.

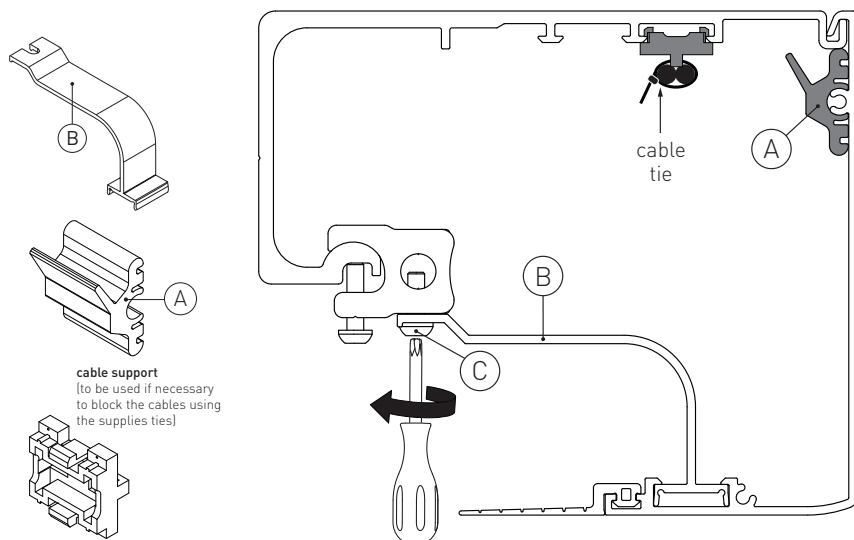

5.3 Example with DAS11M8 and DAS18M8

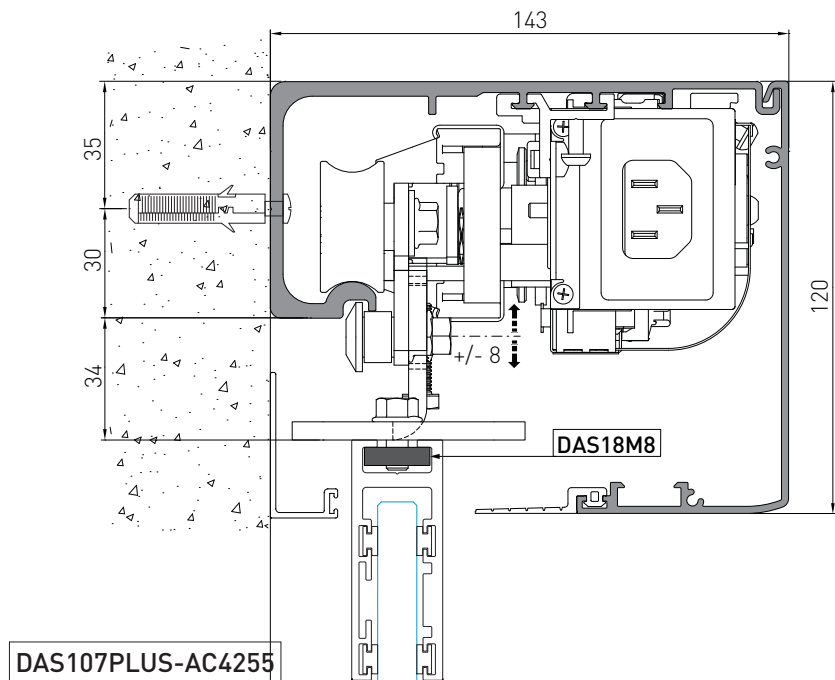
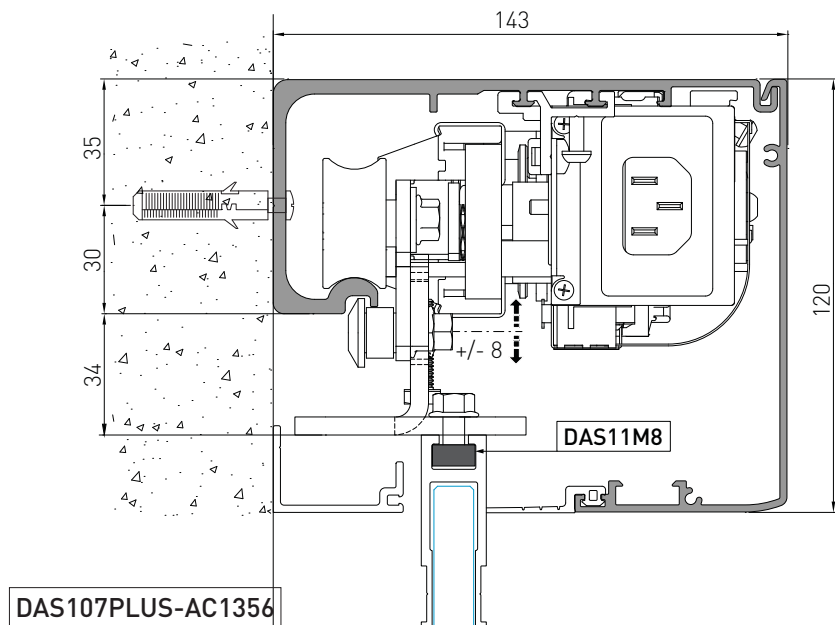

5.4 Preparing the glass door wing

The diagram indicates the process measurements of the AC1356 aluminium profile and glass. $\varnothing 10$ through holes are required on the aluminium profile and $\varnothing 15$ on the glass for fastening. The number of holes and related distance between centres are based on the door wing width. Silicon should ideally be used between the edge of the glass and the internal base of the profile.

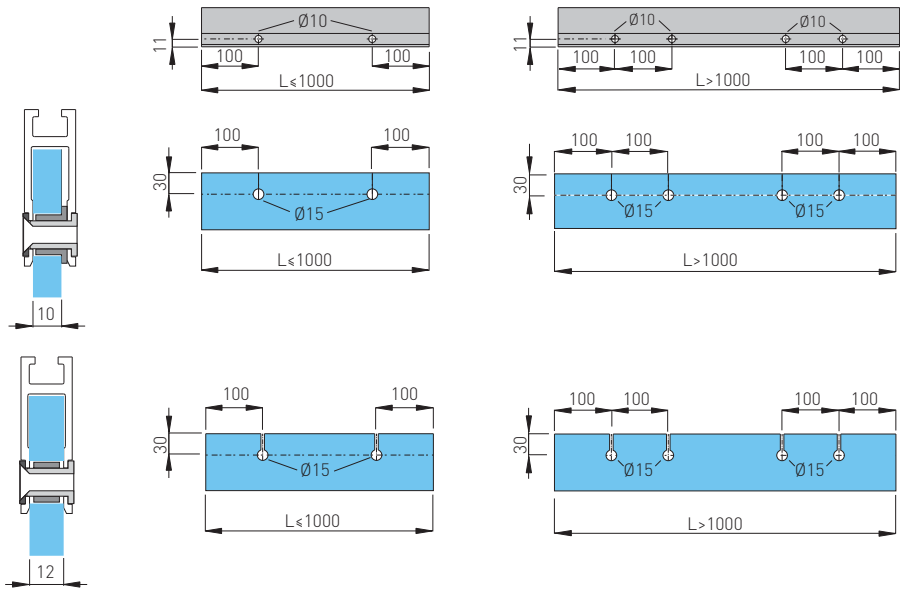

For applications with an AC4255 or AC4870 glass door wing attachment, refer to the relevant manual.

5.5 Installing and adjusting the door wings

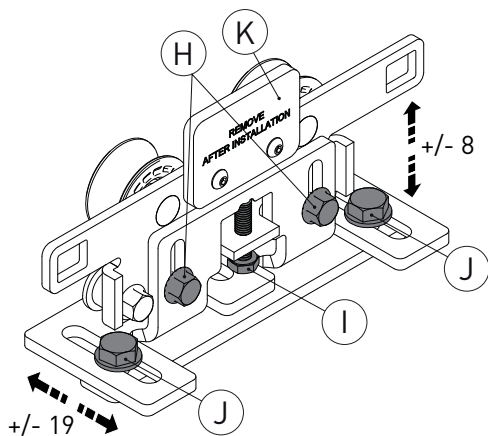

WARNING: after door leaves installation and adjustment REMOVE ALL THE CARRIAGE SELF SUPPORT BRACKETS (K).

Fix the door wing to the carriage with screws [J].

The door wing can be adjusted as shown in the figure.

- loosen the screws [H] and adjust the height by turning the screws [I];
- adjust the side position of the door wing by turning the screws [J];
- move the door wings manually and make sure they move smoothly and freely and that all the wheels rest on the guide.

WARNING: for all-glass door wings without seals, leave a gap of at least 10 mm in the closed position to avoid contact between the glass sheets.

AUTOMATION WITH TWO DOOR WINGS

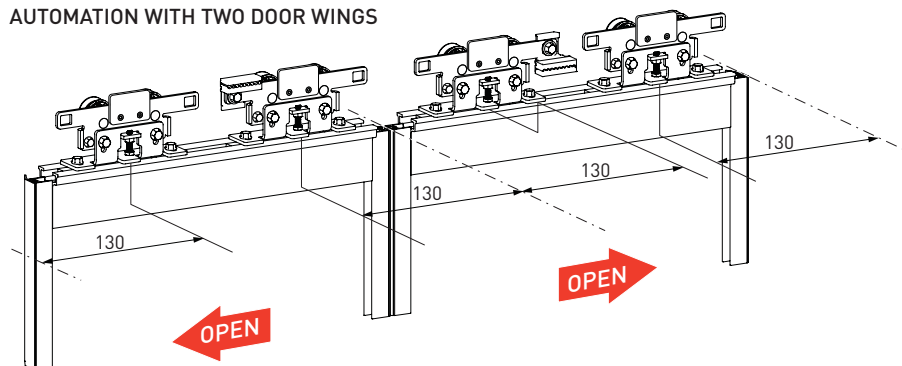

**AUTOMATION WITH ONE DOOR WING WITH
RIGHT-HAND OPENING**

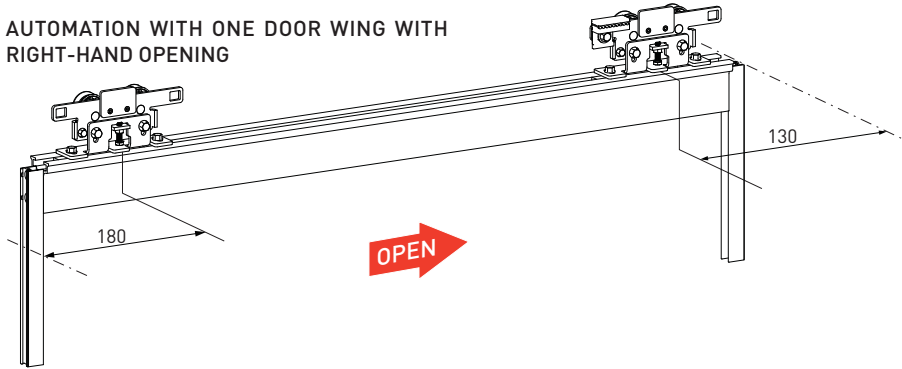

**AUTOMATION WITH ONE DOOR WING WITH
LEFT-HAND OPENING**

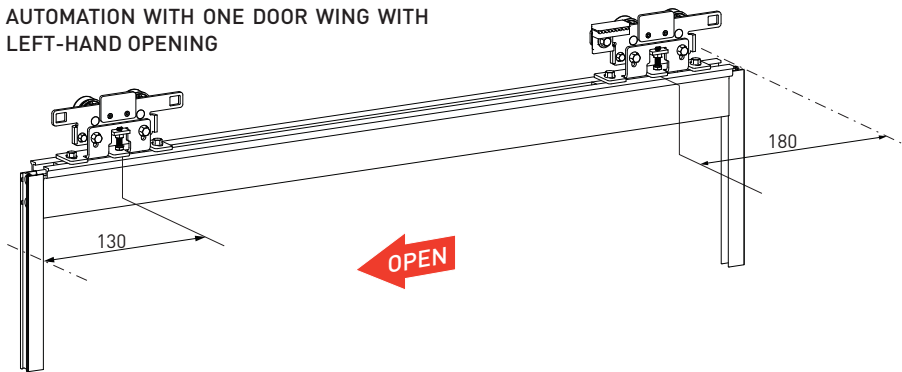

- Place the end stops [E] on the opening and closing positions.
- For the 2 wing automations, a third end stop is provided which must be placed near the end of the box which is used as a stop for the cover support.

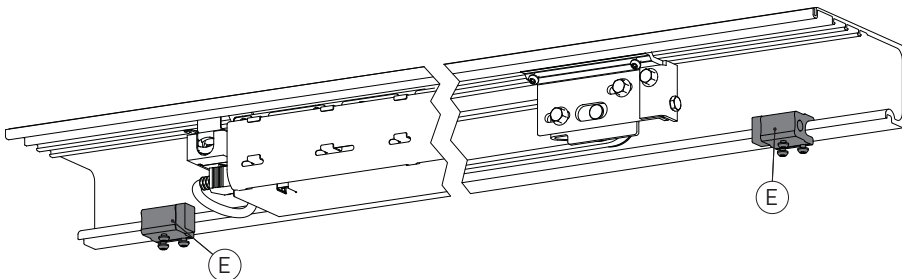

5.6 Installing the floor guides

The floor guides must be made of an anti-friction material such as PVC, NYLON or TEFLON. The length of the floor guide should be no greater than the overlap between the fixed and mobile door wings, and should not enter the passage opening.

Examples of floor guides

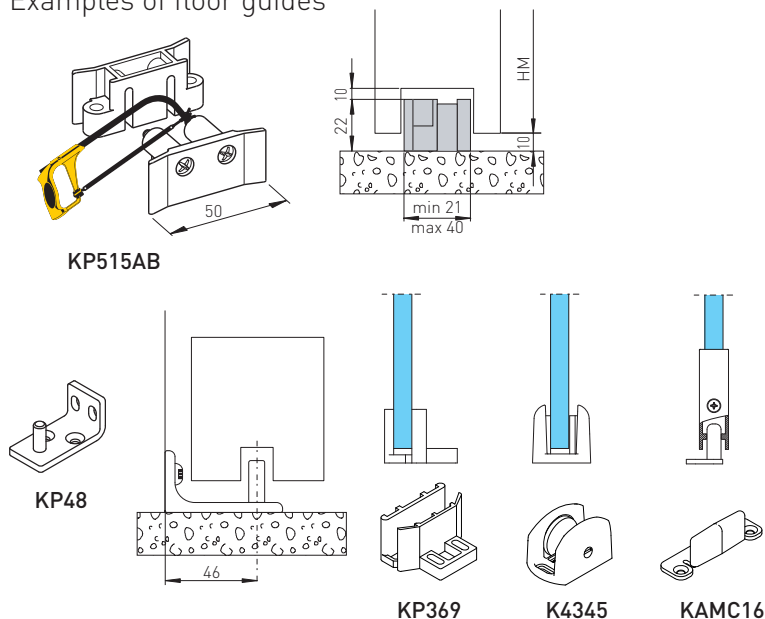

5.7 Adjusting the belt

The belt tension is factory-adjusted and readjustment is normally not needed. If despite this, the belt tension has to be corrected, proceed as follows:

- Loosen the two fixing screws (F).
- Tighten the belt adjustment screw (G), M6, to a torque of 0,9 / 1,1Nm.
- Tighten the two fixing screws (F).

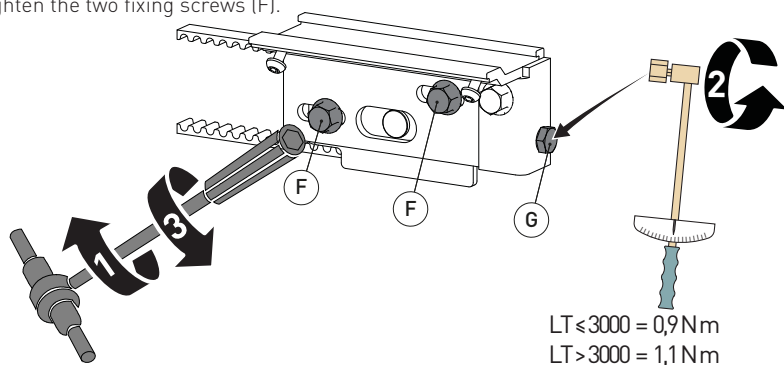

5.8 Installing the door wing block (optional)

A blocking device can be installed to keep the door wings closed. The control panel automatically recognises the type of block installed. For installation, refer to the blocking device installation manual.

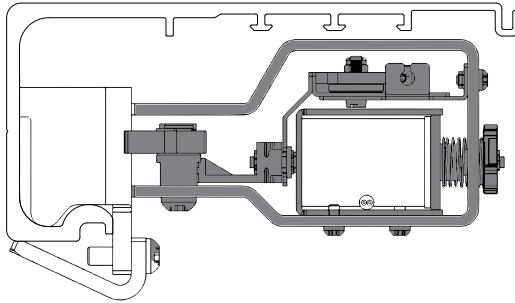

6. Electrical connections



Connect the automation to an efficient earthing system that complies with current safety standards.

During installation, maintenance and repair operations, cut off the power supply before opening the cover to access the electrical parts.

The automation protection casing must be removed by qualified personnel only.

An omnipolar disconnection switch with a contact opening distance of at least 3 mm must be fitted on the mains supply.

Check there is an adequate residual current circuit breaker and overcurrent cutout upstream of the electrical system.

Install an electric switch next to the automatic system.

Make sure there are no sharp edges that may damage the power supply cable.

If the power cable is damaged, have it replaced by the manufacturer or qualified personnel.

- Use a H05RN-F 3G1,5 or H05RR-F 3G1,5 type electric cable.
- Remove the protective cover [1].
- Connect the power cable [2] to the terminal board [4], locking it in place with the cable fastener [3].
- Replace the protective cover [1].
- Connect the connection cable [5] to the power supply unit [6].

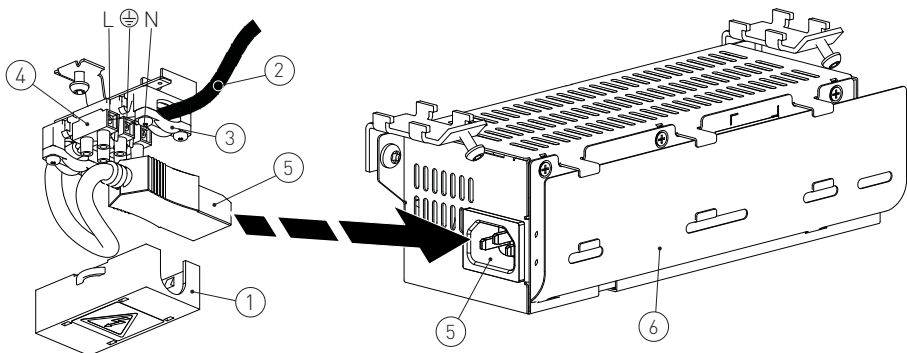

6.1 Standard electrical connections

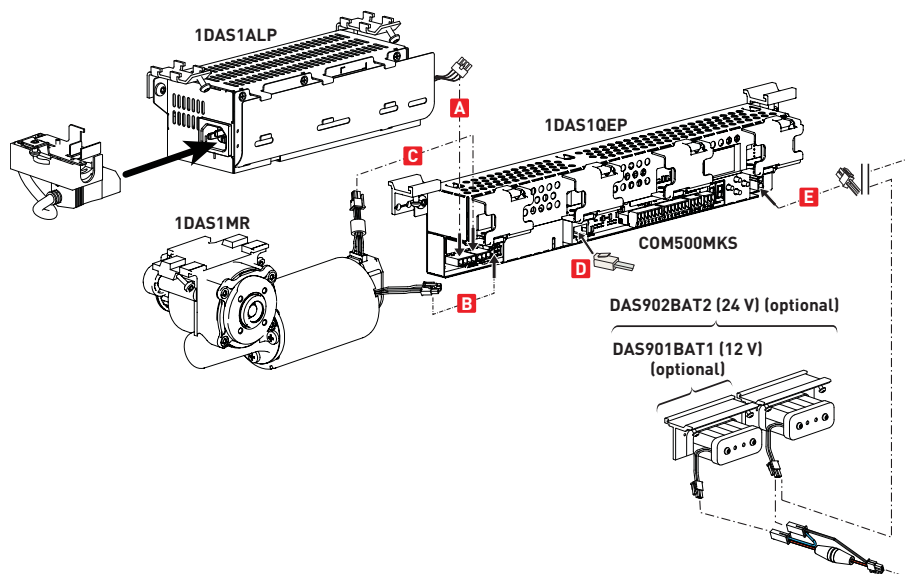

Output	Description
<p>A</p>	Power supply unit connection
<p>B</p>	Motor connection
<p>C</p>	Encoder connection
<p>green LED DO NOT USE </p> <p>D</p>	<p>Used for connection of 1 COM500MKS selector.</p> <p>Green LED: If this LED is switched off or flashing, it means the control panel is malfunctioning;</p>
<p>E</p>	<p>DAS901BAT1 - DAS902BAT2 battery kit connection (optional)</p> <p>In the event of a power failure the operator will carry out an opening operation (factory setting).</p> <p>See parameters 38 and 41 for selection of continuous operation with DAS902BAT2.</p> <p>To charge the batteries, connect the mains power and the battery kit at least 30 minutes before starting the system.</p> <p>WARNING: for charging purposes, the battery kit must be connected to the control panel at all times.</p> <p>Periodically check the efficiency of the battery kit.</p> <p>When there is no voltage, the door can only be opened with a KEY command connected between 8-12.</p> <p>NOTE: use battery type 12V, 1,2mAh NiMH.</p> <p>If a different type of battery is used it can damage!</p>

6.2 Control panel commands





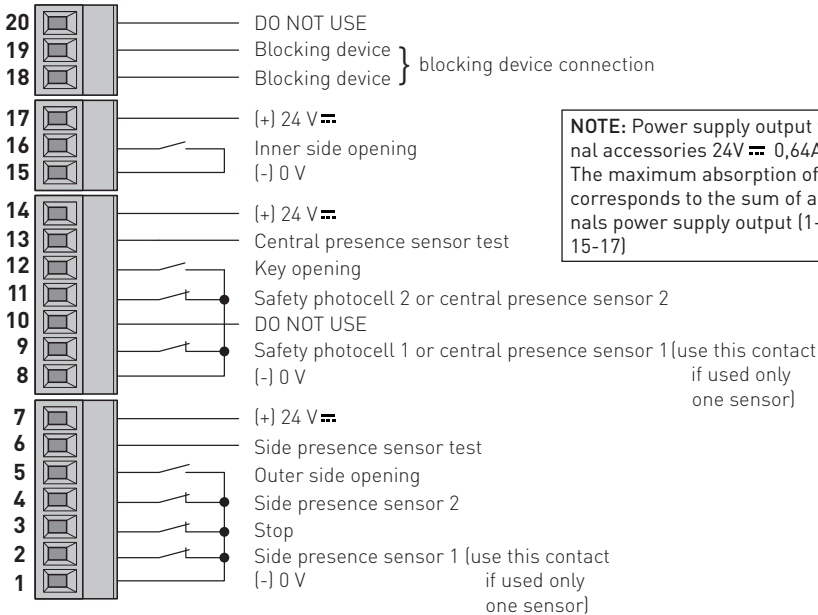











Jumper the unused N.C. contacts









NOTE: Power supply output for external accessories 24V \equiv 0,64A. The maximum absorption of 0,64A corresponds to the sum of all terminals power supply output (1-7; 8-14; 15-17)

6.2.1 Commands

Contact			Description
1  2 (ref. parameter 27)	N.C.	SIDE PRES- ENCE SENSOR 1	Connect side presence sensor 1 as shown in the examples in paragraph 10.2.
1  3 (ref. parameter 46)	N.C.	STOP	The opening of the safety contact causes the current operation to stop. WARNING: when the contact closes again, the door closes. WARNING: The emergency opening (battery 12V), is priority (= door opens in case of mains power failure even if STOP contact is open).
1  4 (ref. parameter 28)	N.C.	SIDE PRES- ENCE SENSOR 2	Connect side presence sensor 2 as shown in the examples in paragraph 10.2.
1  5	N.O.	OUTER SIDE OPENING	Connect the external sensor as shown in the examples in paragraphs 10.1 and 10.2. The closure of the contact activates the door opening operation.
6  (ref. parameter 29)		SIDE PRES- ENCE SENSOR TEST	Connect the test clamp of the side sensors. Clamp 6 activates a test on the side safety sensors before every operation. If the test fails, an alarm message appears on the display.
1  - 7  +		POWER SUPPLY TO ACCESSO- RIES	24V \equiv accessories power supply.

Contact			Description
8  9 (ref. parameter 07)	N.C.	SAFETY PHOTOCELL 1 OR CENTRAL PRESENCE SENSOR 1	Connect safety photocell 1 or central presence sensor 1 as shown in the examples in paragraphs 10.1 and 10.2.
8  11 (ref. parameter 08)	N.C.	SAFETY PHOTOCELL 2 OR CENTRAL PRESENCE SENSOR 2	Connect safety photocell 2 or central presence sensor 2 as shown in the examples in paragraphs 10.1 and 10.2.
8  12 (ref. parameter 04)	N.O.	KEY OPENING	Closing the contact via a key command activates an opening operation and a closing operation after the time selected by parameter 04. If used for opening in DOOR CLOSED mode: - In the presence of a mains power supply or continuity batteries, a 8-12 command partially opens the door and closes it after the time selected by parameter 04. - If there is no mains power supply, a 8-12 command reactivates the batteries, if present, for the time required to perform a complete opening operation and then the batteries are disconnected from the control panel.
13   (ref. parameter 09)		CENTRAL PRESENCE SENSOR TEST	Connect the test clamp of the presence sensors. Command 13 activates a test on the central safety sensors before every operation. If the test fails, an alarm message appears on the display.
8  - 14  +		POWER SUPPLY TO ACCESSORIES	24V  accessories power supply.

Contact			Description
15  16	N.O.	INNER SIDE OPENING	Connect the internal sensor as shown in the examples in paragraphs 10.1 and 10.2. The closure of the contact activates the door opening operation.
15  - 17  +		POWER SUPPLY TO ACCESSORIES	24V  accessories power supply.

Contact			Description
18   19 (ref. parameter 05)		BLOCKING DEVICE CONNECTION	Output for connecting an electro-mechanical block (optional). The blocking device is automatically selected during the learning phase.

7. Adjustment and selection of control functions

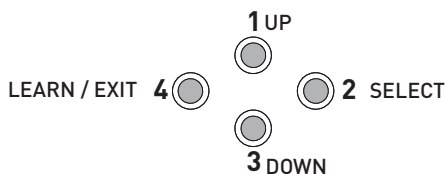

The control panel has a two-figure display that displays text and/or numbers.
It has four buttons.



The procedure to switch on the display is as follows:

 press the 2-SELECT key to launch the display test

NB: make sure all seven segments of the two displays light up correctly to avoid incorrect reading.

- **1 UP:** to increase the parameter number or value in it;
- **2 SELECT:** to enter a parameter or value to be programmed in the memory;
- **3 DOWN:** to decrease the parameter number or value in it;
- **4 LEARN/EXIT:**
 - **LEARN** has 3 functions: 1, 2, 3.
 1. Quick learning. If pressed for longer than 1 second but less than 2, the electronic accessories connected to the control board are recognised.
 2. Normal learning. If pressed for longer than 2 seconds, the display flashes . Two seconds after releasing the button, a complete learning cycle begins which performs an opening and closing operation to carry out the operations described in chapter 8.
 3. Restore factory settings. If pressed for longer than 10 seconds, the control panel restores the factory settings.
 - **EXIT** quits the parameter menu or value without saving the changes. If **EXIT** is not pressed, the control panel returns to the default display  after 3 minutes of inactivity.

N.B.: the set value is stored by the control panel by pressing **SELECT** irrespective of whether the value has been modified or not. Press **EXIT** if you do not want to store the value.

When a value is programmed, that parameter is excluded from the learning cycle. Even if a new learning cycle is executed, that value will not be modified.

To include the parameters in the learning cycle again, the factory settings must be set.

7.1 Status indication on the display

The display shows the different impulses that are active. The status viewing starts with showing "SE" as for Status, then one or many numbers representing the different active impulses in to the operator.

The different impulses are:

- 00**= Key Impulse
- 01**= Inner impulse
- 02**= Outer impulse
- 03**= Synchronisation
- 05**= Presence impulse 1
- 06**= Presence impulse 2
- 07**= Side Presence impulse 1
- 08**= Side Presence impulse 2
- 09**= Stop impulse
- 10**= Emergency open impulse
- 13**= Close command
- 14**= Nurse impulse
- 24**= Push and Go impulse
- 25**= Open-Close impulse
- 28**= Fire impulse
- 47**= Interlock Disable

8. Start up



Before performing any type of operation, make sure that the automation is turned off and the batteries are disconnected.

Start-up and adjustment must be performed in the following order when the automation is installed:

1. Connect the accessories, opening and safety sensors, blocking device, batteries and selector.
2. Jumper the safety contacts **1-2**, **1-3**, **1-4**, **8-9**, **8-11** on the control panel if not used.
3. Connect the mains power supply to the automation.
4. **Set the following parameters:**

Parameter	Description	Settings
09	Central presence sensor test	00 = None (factory setting). 01 = Presence sensor 1 (set if a presence sensor with monitoring is installed). 02 = Presence sensor 1 and 2 (set if two presence sensors with monitoring are installed).
12	Selection of opening direction	00 = right hand opening for single door wing automation. 01 = left hand opening for single door wing automation and for double door automation (factory setting).
29	Side presence sensor test	00 = None (factory setting). 01 = Presence sensor 1 (set if a presence sensor with monitoring is installed). 02 = Presence sensor 1 and 2 (set if two presence sensors with monitoring are installed).
67	Selection of the type of automation	00 = Automation with one door wing. 01 = Automation with two door wings.

5. Leave ajar the casing and, if there are safety sensors, check that they are in standby mode and that there are no people or objects moving in the sensors detection area.
6. Open the cover just enough to press the **LEARN** button for 2 seconds, the display flashes



To enable the stroke and weight of the door wings to be acquired correctly, the acquisition phase must be performed with the door wings installed.

7. Leave ajar the casing without fixing it so that the sensors remain in their working position. Free the area of action of the sensors so that they are detected and monitored during the learning cycle.
8. The automation performs opening and closing operations.

During this cycle, the following accessories connected to the control panel are recognised and some parameters detected:

Accessory / Parameter	Parameter number
Presence of block and type	05, 06
Whether the sensors are monitored or not	9, 29
Presence of battery and type	41
Measurement of width of passage opening	-
Calculation of weight of door wing[s]	-

At the end of the learning cycle, the door remains closed and the display indicates

If some parameters have not been automatically configured during the learning cycle, the door opens. The display first indicates , and then the parameter that has not been acquired automatically, for example, if the door is a 2-wing or 1-wing door (parameter 67).

The parameters P05, P06, P67 can be configured by the installer and/or check that there are no obstacles and friction which prevents correct learning of open position and door weight, shown as P59, P68, P69. Remove obstacles and repeat the learning process.

1. Press the **SELECT** button to start to modify the parameters.
2. Press **SELECT** again to display the parameter value in flashing mode.
3. Select the correct value using the **UP** and **DOWN** buttons.
4. Press **SELECT** to confirm and program the selected value.
5. Continue to configure the other parameters that have not been acquired
6. Press **LEARN/EXIT** for more than 2 seconds and the display will indicate , after 2 seconds, the door closes and is ready for operating.

If necessary, you can adjust the following main parameters:

	00	Selection of opening speed (cm/s) (10÷70, 10= 10cm/s; 70= 50cm/s)
	02	High Speed Closing (cm/s) (10÷70, 10= 10cm/s; 70= 50cm/s)
	03	Selection of automatic closing time (00÷60s)
	11	Partial opening selection (00-99%)
	15	Acceleration and braking performance adjustment (01÷05) 01= minimum performance, for light door wings 05= maximum performance, for heavy door wings
	38	Selection of continuous operation with 24V DAS902BAT2 battery (00÷01) 00= Off 01= On
	49	Adjustment of the maximum opening force (02÷19N x10) If the reopening maneuver occurs too abruptly, set parameter 49 with a value lower than the factory value (08), example 04 - 05.

- For other parameter variations, see the "Parameters" chapter.
- Make sure the installation complies with the current regulations and the essential requisites laid down by the relevant authorities.
- At the end of the start-up close the cover and fix it with the appropriate screws, see chapter 5.1.

9. Parameters

9.1 Configuration parameters according to function

For more information on the parameters, see par. 9.2

SPEED parameters		
Parameter	Description	Range
00	High Speed Opening (10= 10cm/s; 70= 50cm/s)	10-50cm/s
02	High Speed Closing (10= 10cm/s; 70= 50cm/s)	10-50cm/s
TIME parameters		
Parameter	Description	Range
03	Hold Open Time	00-60s
04	Key Hold Open Time	00-60s
FUNCTION parameters		
Parameter	Description	Range
12	Opening direction. One wing open right (00) / one wing open left and two wings (01)	00-01
5E	Status indication. Off (00) / On (01)	00-01
67	Door type. 00 (1 wing) - 01 (2 wings)	00-01
POSITION parameters		
Parameter	Description	Range
11	Partial open position	00-99%
DRIVE parameters		
Parameter	Description	Range
15	Acceleration and braking performance. Minimum(01)/maximum(05)	01-05
49	Opening max. force	02-19 N x10
4A	End checking closing thrust	00-19 N x10
50	Closing max. force	02-19 N x10
EMERGENCY parameters		
Parameter	Description	Range
38	Continuity with battery. OFF (00) / ON (01)	00-01
41	Battery type. No battery (00) / 12V (01) / 24V (02)	00-02
LOCK parameters		
Parameter	Description	Range
05	Block type. No block (00) / DO NOT USE (01, 02) / antipanic block (03) / standard block (04) / DO NOT USE (05)	00-05
06	Closing thrust before opening. OFF (00) / ON (01)	00-01
43	Opening delay for lock	00-99s x 10
51	Push & Close. Off (00) / On (01)	00-01
52	Push & CloseTimeout	00-99s x 10
SENSOR parameters		
Parameter	Description	Range
07	Photocell contact 1 or central presence sensor 1. N.O. (00) / N.C. (01)	00-01
08	Photocell contact 2 or central presence sensor 2. N.O. (00) / N.C. (01)	00-01
09	Central presence sensor test. None (00) / sensor 1 (01) / sensor 1 and 2 (02)	00-02
27	Side presence sensor contact 1. N.O. (00) / N.C. (01)	00-01
28	Side presence sensor contact 2. N.O. (00) / N.C. (01)	00-01
29	Side presence sensor test. None (00) / sensor 1 (01) / sensor 1 and 2 (02)	00-02
30	Side presence activation distance	00-99dm
31	Type of sensor. Monitoring with 1 wire (00) / 2 wires (01)	00-01
46	STOP configuration. N.O. (00) / N.C. (01)	00-01

9.2 Description of the parameters



In the "INSTALLATION SETTINGS" column you can note the modified setting values.

Parameter	Description	Factory setting	Installation setting
00	Selection of opening speed (10÷70, 10= 10cm/s; 70= 50cm/s for single door wing) Sets the maximum opening speed.	40	
02	Selection of closing speed (10÷70, 10= 10cm/s; 70= 50cm/s for single door wing) Sets the maximum closure speed.	AUTO	
03	Selection of automatic closing time (00÷60s) Adjusts the time during which the automation remains open following an internal or external opening command.	00	
04	Selection of automatic closing time after a key command "KEY" (00÷60s) Adjusts the time during which the automation remains open following a key opening command "KEY".	07	
05	Selection of block type (00÷05) 00= no block. 01= DO NOT USE. 02= DO NOT USE. 03= anti-panic block. 04= standard block. 05= DO NOT USE.	AUTO	
06	Closure thrust before the opening operation (00÷01) 00= Disabled. 01= Enabled. If enabled (01), the automation applies a closure thrust to guarantee a correct release when the electric lock opens.	AUTO	
07	Photocell contact 1 or central presence sensor 1 (00÷01) 00= N.O. 01= N.C.	01	
08	Photocell contact 2 or central presence sensor 2 (00÷01) 00= N.O. 01= N.C.	01	
09	Central presence sensor test (00÷02) 00= None 01= Presence sensor 1 (set if a presence sensor with monitoring is installed). 02= Presence sensor 1 and 2 (set if two presence sensors with monitoring are installed).	TO BE SET	
11	Partial opening selection (00-99%)	50	
12	Selection of opening direction (00÷01) 00= right hand opening for single door wing automation; 01= left hand opening for single door wing automation and for double door automation.	01	
15	Acceleration and braking performance adjustment (01÷05) 01= Minimum performance, for light door wings; 05= maximum performance, for heavy door wings.	03	
27	Selection of the contact on side presence sensor 1 (00÷01) 00= N.O. 01= N.C.	01	

Parameter	Description	Factory setting	Installation setting
28	Selection of the contact on side presence sensor 2 (00÷01) 00= N.O. 01= N.C.	01	
29	Side presence sensor test (00÷02) 00= None. 01= Presence sensor 1 [set if a presence sensor with monitoring is installed]. 02= Presence sensor 1 and 2 [set if two presence sensors with monitoring are installed].	TO BE SET	
30	Adjustment of activation distance for side presence sensor (00-99dm) Adjusts the distance within which the side presence sensor intervenes. 00= minimum. During the automation opening phase, the entire stroke is performed at reduced speed. 01-99= the sensor is activated only in the last selected opening decimetres.	00	
31	Selection of the type of sensor (00÷01) Selects the type of monitoring for the combined sensors. 00= Sensor with monitoring (1 wire): the combined sensors have only one test input for both the detection range and the control range. 01= Sensor with monitoring (2 wires): the sensors have separate test inputs both for detection and control.	01	
38	Selection of continuous operation with 24V DAS902BAT2 battery (00÷01) 00= Disabled. 01= Enabled. If the 24V battery kit is used, the automation continues working even if there is a power failure (flat batteries: last operation= opening).	00	
41	Selection of the type of battery (00÷02) 00= No battery. 01= 12V (only emergency open). 02= 24V (continuous operation).	AUTO	
43	Adjustment of the opening delay with blocking device (00÷99s x 0.1) Adjusts the opening delay time when a blocking device is installed, if the selector is set on CLOSED DOOR or ONE-WAY.	00	
46	Selection of the STOP contact (00÷01) 00= N.O. 01= N.C.	01	
49*	Adjustment of the maximum opening force (02÷19N x10) The force applied from the operator to the door leaf during opening.	08	
4A	Adjustment of the thrust to verify the closure end stop (00÷19N x10)	05	
50	Adjustment of maximum force during closure (02÷19N x10) The force applied from the operator to the door leaf during closing.	15	
51**	Push&Close (00÷01) When this parameter is set to On (01) the motor will in operation mode selections OFF or EXIT try to close the door with the force selected by parameter 50 "Closing Max Force", if someone tries to open it manually. Push & Close is also known as "poor man's lock". 00= Off. 01= On.	00	

Parameter	Description	Factory setting	Installation setting
52**	Push & Close Timeout(00÷99s x0,1) Adjustable time for how long time the door will continue to "fight back" when someone is trying to force it open. 00= infinite time.	00	
5E**	Status indication (00÷01) The operator shows the status indication on the LED display of the control panel. See paragraph 7.1 for more information. 00= Off. 01= On.	01	
67	Selection of the type of automation (00÷01) 00= Automation with one door wing. 01= Automation with two door wings.	TO BE SET	



10. Example of connection

10.1 Example of connection with opening radar and photocell

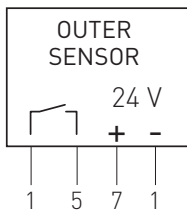
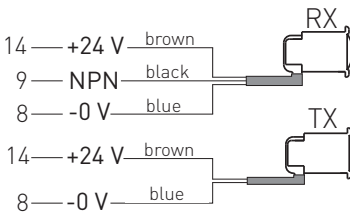
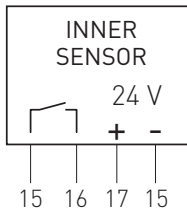
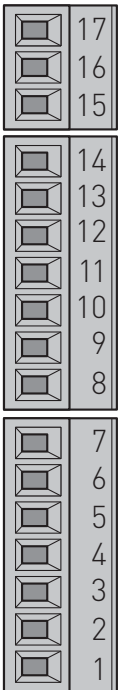
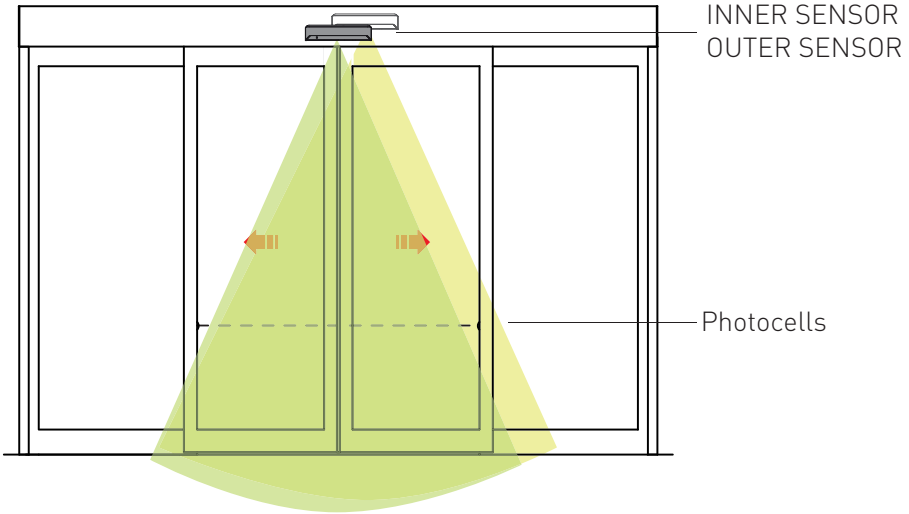

**Photocell
DAS900PH1A**

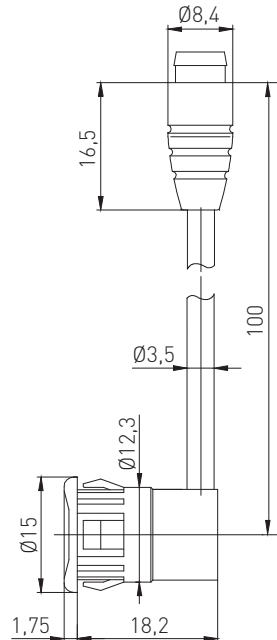

IP2282EN

10.2 Combined opening and safety sensor + safety sensor on opening



The electrical connections must be made when the mains power supply is switched off.

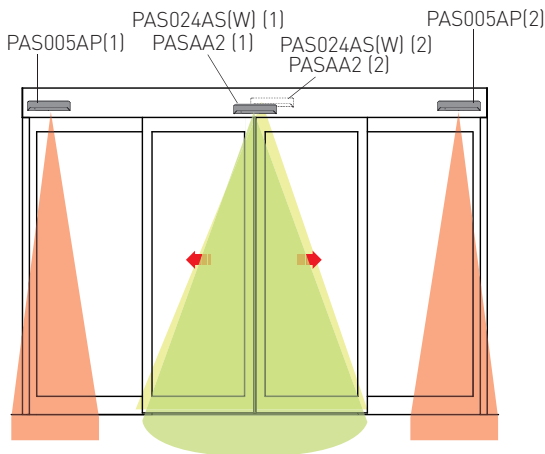

With these connections, the automation opens and makes a reversal safety contact on the passage opening with a command from the internal and/or external sensor.

Opening safety is guaranteed by the auto-control side sensors.

NB: If only one sensor is connected, refer to the sensor connections (1).

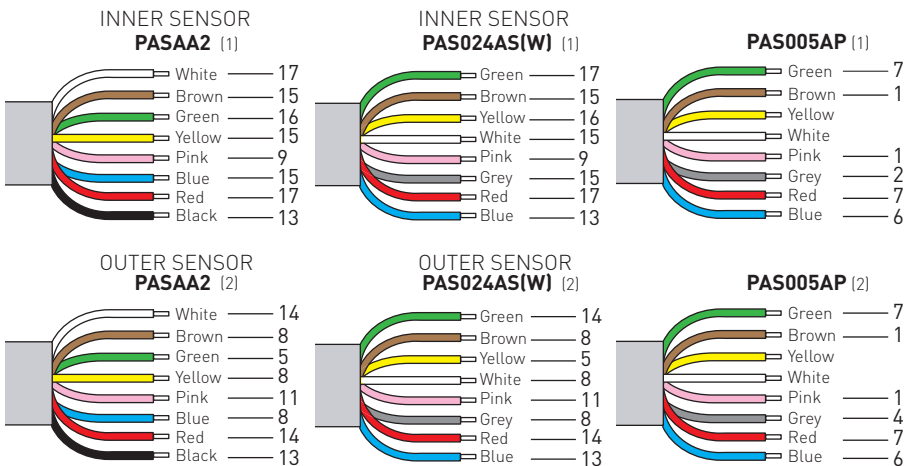

Set the selection DIP switches on sensor PASAA2 as shown below:



For more information on how the sensors switches work, refer to the relevant installation manuals.

If used also photocell in combination with sensors (ref. paragraph 10.1):

- not connect the blue wire of sensor to terminal 15;
- not connect the NPN wire of photocell receiver to terminal 9;
- connect the blue wire of sensors and the NPN wire of receiver together.

11. Troubleshooting / alarms

Problem	Solution
The automation doesn't open and the motor doesn't start up	Check and change the functions selector switch settings.
	Make sure there are no objects on the sensor's detection path.
	Check the power supply switch inside the building.
The motor starts up but the automation doesn't open	Check any locks, releasing them if necessary.
	Make sure there are no objects hindering the opening of the automation.
The automation doesn't close	Check and change the functions selector switch settings.
	Make sure there are no objects on the sensor's detection path.
The automation opens and closes by itself.	Make sure there are no moving elements on the sensor's detection area.
The reopening maneuver occurs too abruptly	Set parameter 49 with a lower value , example 04-05

11.1 Alarms

- The control panel display shows error signals.
- During normal operation, the display shows **00**.
- If the display is switched off, check the mains power supply and the power cable.
- When there is an alarm, the display alternates the error type (e.g. **E 4** - Motor error) with a 2-figure number indicating the specific error (e.g. **03** - Encoder error).
- If there are several errors, they will be visualised in alphabetic order and in sequence.
- It is possible to give a RESET to the control unit by the function selector switch.
- Alternatively, disconnect the power supply and battery, if present, and then reconnect them.
- If the problem persists check below error list.
- On each control panel there is a green LED.
- If this LED is switched off or flashing, this means the control panel is malfunctioning.

Main error: Power Supply		
Error	Cause	Solution
--	There is not enough power to the control unit	Check that the power does not drop from the Power supply unit, check cables. Replace the Power supply unit

E1 - Sensor error		
Error	Cause	Solution
31	Side presence command error. The control panel hasn't received a check response from the side presence sensor.	Make sure the sensor is correctly connected (especially the test contact). Replace the side presence sensor.
32	Presence command error. The control panel hasn't received a check response from the presence sensor.	Make sure the sensor is correctly connected (especially the test contact). Replace the presence sensor.

E3 - Control panel error

Error	Cause	Solution
00	Internal RAM memory error	Make a RESET. If the problem persists, replace the control panel. The green LED flashes or is switched off.
01	Internal ROM memory error	Make a RESET. If the problem persists, replace the control panel. The green LED flashes or is switched off.
02	Serious internal EEPROM memory error	Make a RESET. If the problem persists, replace the control panel.
05	Ambient temperature measuring error	Make a RESET. If the problem persists, replace the control panel.
06	Motor pilot fault (break chopper)	Make a RESET. If the problem persists, replace the control panel.
08	A/D converter error	Make a RESET. If the problem persists, replace the control panel. The green LED flashes or is switched off.
10	Registration error within the program	Make a RESET. If the problem persists, replace the control panel. The green LED flashes or is switched off.
11	Error within the program	Make a RESET. If the problem persists, replace the control panel. The green LED flashes or is switched off.
14	Blocking device current error	Check the blocking device is correctly installed. If the problem persists, replace it. Make a RESET. If the problem persists, replace the control panel.
17	Watchdog hardware error The connection to the motor cannot be disabled	Make a RESET. If the problem persists, replace the control panel.
18	Serious EEPROM writing error. Cannot change the configuration parameter.	Make a RESET. If the problem persists, replace the control panel.
22	24V output overcurrent error.	Make a RESET. If the problem persists, check the sensors and accessories connected to the 24V output. Make a RESET. If the problem persists, replace the control panel. The green LED flashes or is switched off.
23	Blocking device error. Cannot release the blocking device with the relative relay.	Make a RESET. If the problem persists, replace the control panel.
24	Learning error. The learning cycle has been suspended.	Check the automation performs a complete opening and closure cycle. Check the friction. Launch a new learning cycle.
27	Blocking device or bistable error	Check the correct blocking device is being used. If the problem persists, replace the blocking device.
33	Serious programming error	Make a RESET. If the problem persists, replace the control panel.
34	Output activation error. Fault test on safety circuits.	Make a RESET. If the problem persists, replace the control panel.
35	Connection voltage error.	Make a RESET. If the problem persists, replace the control panel.

E4 - Motor/encoder error

Error	Cause	Solution
03	Encoder error. The encoder, encoder cable or motor cable is damaged.	Check the encoder and motor connections.
04	Motor current error The motor cable or encoder cable is damaged.	Make sure the connection is correct.
09	Encoder cable error The encoder cable is damaged	Check the encoder cable, and replace it if necessary.

E5 - Blocking device error

Error	Cause	Solution
07	Faulty blocking device The blocking device or an obstacle more than 14mm from the closing stop is preventing the automation from opening.	Check the blocking device and make sure there are no obstacles or mechanical jamming. Make sure the parameter closure thrust before the opening operation 06 is correctly set.

E6 - Communication error

Error	Cause	Solution
12	Motor control communication error. Motor control processor disconnected from the circuit.	Make a RESET. If the problem persists, replace the control panel.
13	Automation control communication error Automation control processor disconnected from the circuit	Make a RESET. If the problem persists, replace the control panel.

E7 - Motor temperature error

Error	Cause	Solution
16	The automation work cycle is too high for the speed and open automation time settings.	If the motor is hot, bring the automation to OPEN DOOR mode and wait for at least 1 minute. Reduce the speed and increase the open automation time.

E8 - Non-critical error

Error	Cause	Solution
49	Non-critical EEPROM writing error	Make a RESET. If the problem persists, replace the control panel.
50	EEPROM full	There are too many data to be recorded. Reduce the amount of data in the register configuration.

IMPORTANT

After removing the fault or replacing the automation components, check the following:

1. the movement of the door (adjust the necessary parameters so that the door works correctly);
2. the parameters relating to accessories have been correctly set;
3. the installation complies with local laws and the minimum requisites of the relevant authorities.

12. Routine maintenance plan

Perform the following operations and checks every 6 months, according to the intensity of use of the automation.

With 230V~ power supply and batteries disconnected:

- Clean and lubricate the mobile parts (the carriage slide guides and the floor guides).
- Check the belt and its tension.
- Clean sensors and photocells.
- Check the stability of the automatic system and make sure that all screws are correctly tightened.
- Check the alignment of the door wings, the position of the end stops, and the correct introduction of the blocking device.

With 230V~ power supply and batteries connected:

- Check the blocking system is working correctly.
- Check the stability of the automation, and make sure it moves smoothly.
- Check that all control functions are operating correctly.
- Make sure the command and safety sensors are working correctly.
- Make sure the forces developed by the automation meet the requisites of the applicable regulations.
- Check the correct functioning of the batteries.



NB: for spare parts, see the spares price list.



Only use original spare parts for repairing or replacing products.

The installer must supply all information concerning the automatic, manual and emergency operation of the motorised automation or gate, and must provide the user with the operating instructions.

The installer must prepare and keep a maintenance record showing all the routine and extraordinary maintenance work carried out.

All the rights concerning this material are the exclusive property of Entrematic Group AB.

Although the contents of this publication have been drawn up with the greatest care, Entrematic Group AB cannot be held responsible in any way for any damage caused by mistakes or omissions. We reserve the right to make changes without prior notice.

Copying, scanning or changing in any way is expressly forbidden unless authorised in writing by Entrematic Group AB.

ENTRE//MATIC



Entrematic Group AB
Lodjursgatan 10
SE-261 44, Landskrona
Sweden
www.entrematic.com

